

CMSH3-20M CMSH3-60M
 CMSH3-40M CMSH3-100M

**SURFACE MOUNT SILICON
 SCHOTTKY RECTIFIERS
 3.0 AMP, 20 THRU 100 VOLT**



SMB CASE



www.centrasemi.com

DESCRIPTION:

The CENTRAL SEMICONDUCTOR CMSH3-20M series 3.0 Amp surface mount silicon Schottky rectifier is a highly reliable component designed for use in all types of commercial, industrial, entertainment, computer, and automotive applications.

MARKING CODE: SEE MARKING CODE TABLE ON FOLLOWING PAGE

FEATURES:

- High current capability
- Flammability classification UL94V-0

MAXIMUM RATINGS: ($T_A=25^\circ\text{C}$ unless otherwise noted)

	SYMBOL	CMSH3 -20M	CMSH3 -40M	CMSH3 -60M	CMSH3 -100M	UNITS
Peak Repetitive Reverse Voltage	V_{RRM}	20	40	60	100	V
DC Blocking Voltage	V_R	20	40	60	100	V
RMS Reverse Voltage	$V_{R(RMS)}$	14	28	42	71	V
Average Forward Current ($T_L=75^\circ\text{C}$)	I_O			3.0		A
Peak Forward Surge Current, $t_p=8.3\text{ms}$	I_{FSM}			80		A
Operating and Storage Junction Temperature	T_J, T_{stg}		-65 to +150			$^\circ\text{C}$
Thermal Resistance	Θ_{JL}		20			$^\circ\text{C/W}$

ELECTRICAL CHARACTERISTICS: ($T_A=25^\circ\text{C}$ unless otherwise noted)

SYMBOL	TEST CONDITIONS	TYP	MAX	UNITS
I_R	V_R =Rated V_{RRM}		500	μA
I_R	V_R =Rated V_{RRM} , $T_A=100^\circ\text{C}$		20	mA
V_F	$I_F=3.0\text{A}$ (CMSH3-20M, -40M)	0.48	0.55	V
V_F	$I_F=3.0\text{A}$ (CMSH3-60M)	0.56	0.75	V
V_F	$I_F=3.0\text{A}$ (CMSH3-100M)	0.75	0.85	V
C_J	$V_R=4.0\text{V}$, $f=1.0\text{MHz}$ (CMSH3-20M)	139		pF
C_J	$V_R=4.0\text{V}$, $f=1.0\text{MHz}$ (CMSH3-40M)	167		pF
C_J	$V_R=4.0\text{V}$, $f=1.0\text{MHz}$ (CMSH3-60M)	121		pF
C_J	$V_R=4.0\text{V}$, $f=1.0\text{MHz}$ (CMSH3-100M)	87		pF

CMSH3-20M CMSH3-60M
 CMSH3-40M CMSH3-100M

**SURFACE MOUNT SILICON
 SCHOTTKY RECTIFIERS
 3.0 AMP, 20 THRU 100 VOLT**



SMB CASE - MECHANICAL OUTLINE

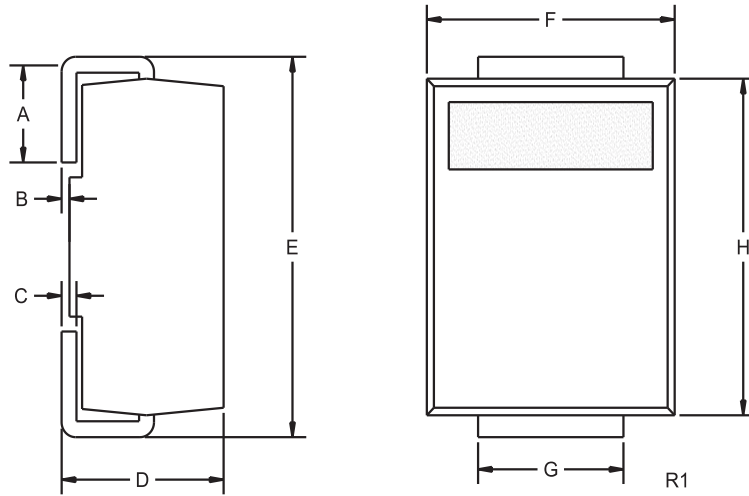

DEVICE	MARKING CODE
CMSH3-20M	CS320M
CMSH3-40M	CS340M
CMSH3-60M	CS360M
CMSH3-100M	CS3100M

SYMBOL	DIMENSIONS			
	INCHES		MILLIMETERS	
	MIN	MAX	MIN	MAX
A	0.030	0.060	0.76	1.52
B	0.004	0.008	0.10	0.20
C	0.006	0.012	0.15	0.30
D	0.086	0.096	2.18	2.44
E	0.200	0.220	5.08	5.59
F	0.130	0.150	3.30	3.81
G	0.077	0.083	1.96	2.11
H	0.160	0.180	4.06	4.57

SMB (REV: R1)

R4 (8-January 2016)

CMSH3-20M CMSH3-60M
 CMSH3-40M CMSH3-100M

SURFACE MOUNT SILICON
 SCHOTTKY RECTIFIERS
 3.0 AMP, 20 THRU 100 VOLT



TYPICAL ELECTRICAL CHARACTERISTICS

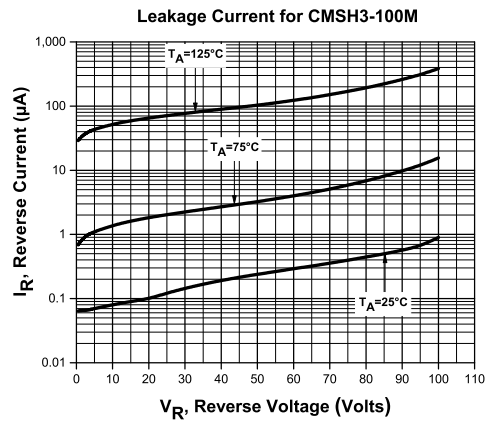
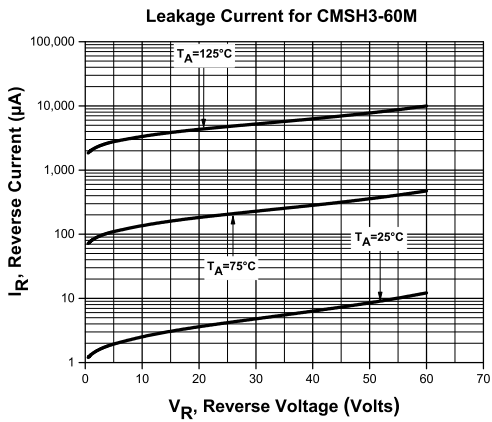
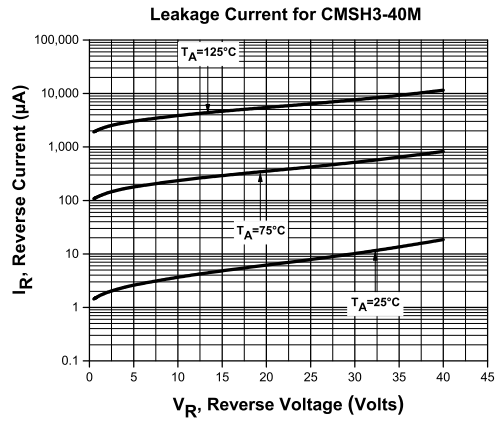
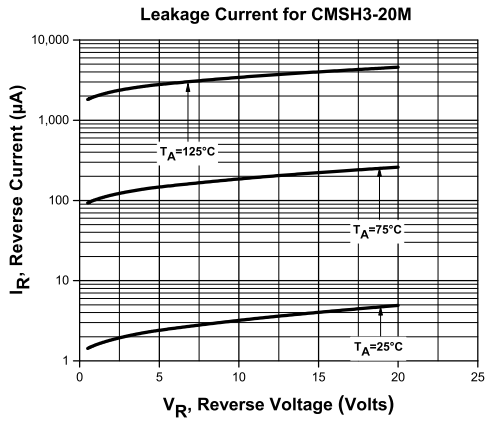

R4 (8-January 2016)

CMSH3-20M CMSH3-60M
 CMSH3-40M CMSH3-100M

SURFACE MOUNT SILICON
 SCHOTTKY RECTIFIERS
 3.0 AMP, 20 THRU 100 VOLT



TYPICAL ELECTRICAL CHARACTERISTICS

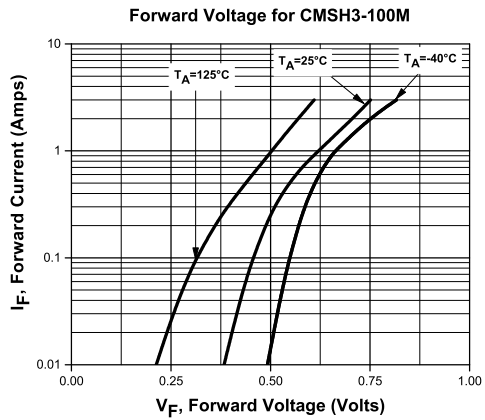
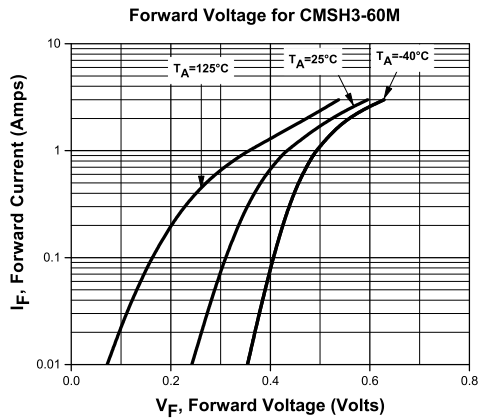
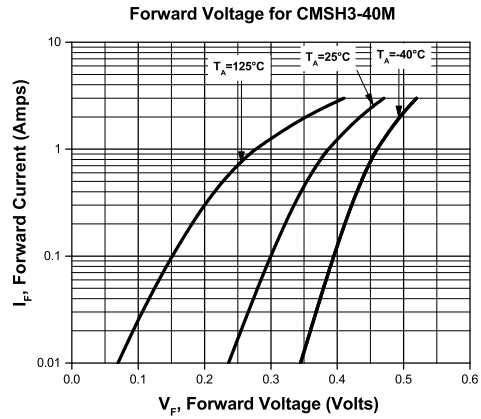
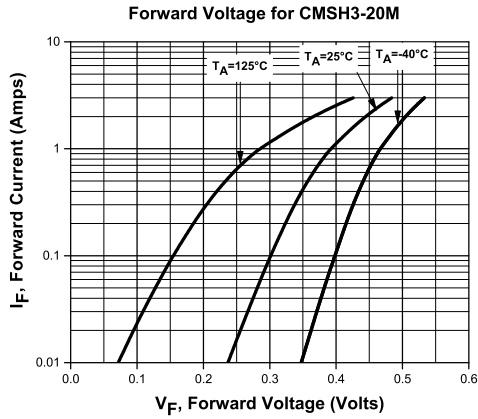

R4 (8-January 2016)

CMSH3-20M CMSH3-60M
CMSH3-40M CMSH3-100M

SURFACE MOUNT SILICON
SCHOTTKY RECTIFIERS
3.0 AMP, 20 THRU 100 VOLT



TYPICAL ELECTRICAL CHARACTERISTICS

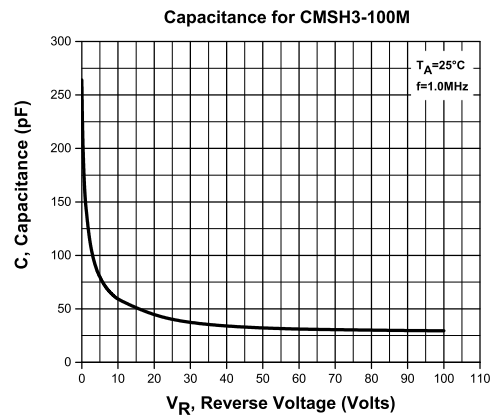
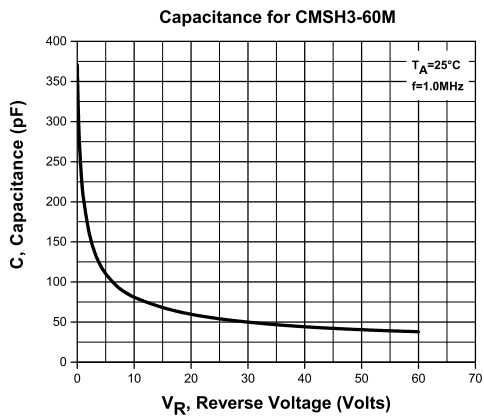
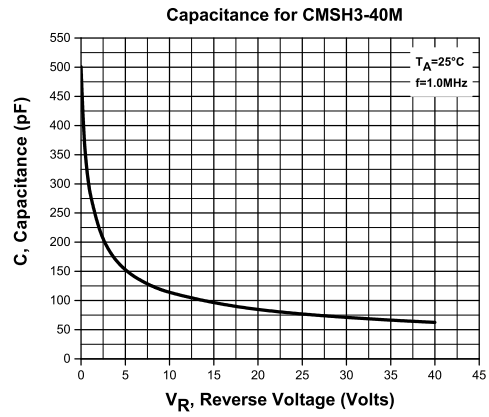
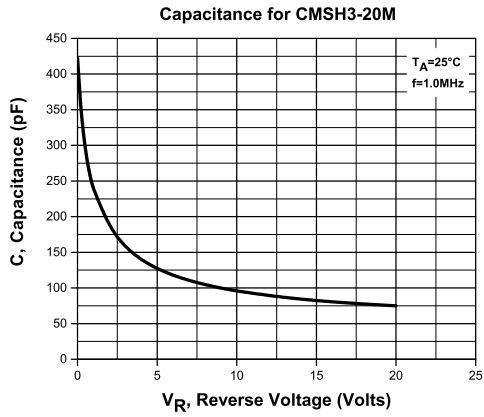

R4 (8-January 2016)

CMSH3-20M CMSH3-60M
CMSH3-40M CMSH3-100M

SURFACE MOUNT SILICON
SCHOTTKY RECTIFIERS
3.0 AMP, 20 THRU 100 VOLT



TYPICAL ELECTRICAL CHARACTERISTICS

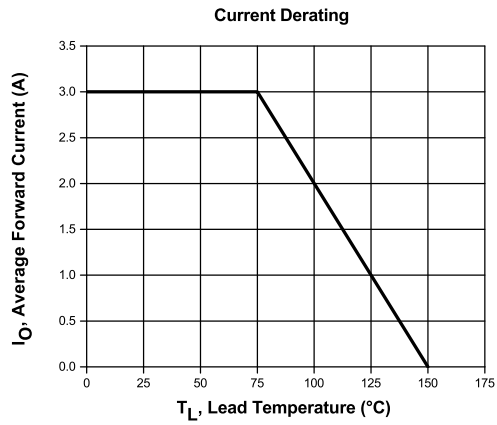

R4 (8-January 2016)

OUTSTANDING SUPPORT AND SUPERIOR SERVICES



PRODUCT SUPPORT

Central's operations team provides the highest level of support to insure product is delivered on-time.

- Supply management (Customer portals)
- Inventory bonding
- Consolidated shipping options
- Custom bar coding for shipments
- Custom product packing

DESIGNER SUPPORT/SERVICES

Central's applications engineering team is ready to discuss your design challenges. Just ask.

- Free quick ship samples (2nd day air)
- Online technical data and parametric search
- SPICE models
- Custom electrical curves
- Environmental regulation compliance
- Customer specific screening
- Up-screening capabilities
- Special wafer diffusions
- PbSn plating options
- Package details
- Application notes
- Application and design sample kits
- Custom product and package development

CONTACT US

Corporate Headquarters & Customer Support Team

Central Semiconductor Corp.
145 Adams Avenue
Hauppauge, NY 11788 USA
Main Tel: (631) 435-1110
Main Fax: (631) 435-1824
Support Team Fax: (631) 435-3388
www.centalsemi.com

Worldwide Field Representatives:
www.centalsemi.com/wwreps

Worldwide Distributors:
www.centalsemi.com/wwdistributors

For the latest version of Central Semiconductor's **LIMITATIONS AND DAMAGES DISCLAIMER**, which is part of Central's Standard Terms and Conditions of sale, visit: www.centalsemi.com/terms